

The new E-Class LWB



Mercedes-Benz





New E, New Attitude.



Ahead in safety.



Unbeatable comfort.



Intelligence at its best.



Diesel Engine - E 350d

The most powerful diesel engine in the history of Mercedes-Benz bundles together state-of-the-art technology components. As a result, the engine sets standards in terms of agility and consumption. More than an additional bonus: the six-cylinder in-line engine boasts an unsurpassed level of refinement.



Diesel Engine - E 220d

These 4-cylinder diesel engines of the latest generation give a lot but take little. This is thanks to their particularly light, compact design and minimal frictional losses. Significantly less noise and vibrations bring the level of refinement virtually to that of petrol engines.



Petrol Engine - E 200

The highly advanced engine technology manifests itself in enormous power with a low fuel consumption. One major reason for this is the intelligent combustion system with a combination of direct injection and multi-spark ignition. Demand-controlled ancillary units also increase efficiency.

9G-TRONIC. The driving force masquerading as a transmission.

With nine forward gears, the 9G-TRONIC automatic transmission enables efficiency, comfort and dynamism of an entirely new dimension. Its high efficiency helps to reduce fuel consumption. The larger ratio range allows a reduction in engine speed. Performance remains excellent while ride comfort is enhanced and noise levels are cut. The reduced intervals between the gears lead to faster gear changes and enhanced spontaneity and agility. As the 9G-TRONIC is able to skip individual gears, multiple downshifts are possible for fast and powerful sprints.

Powertrain systems

The standard-fit ECO start/stop function shuts off the engine temporarily at a red light or in a traffic jam to further lower fuel consumption.

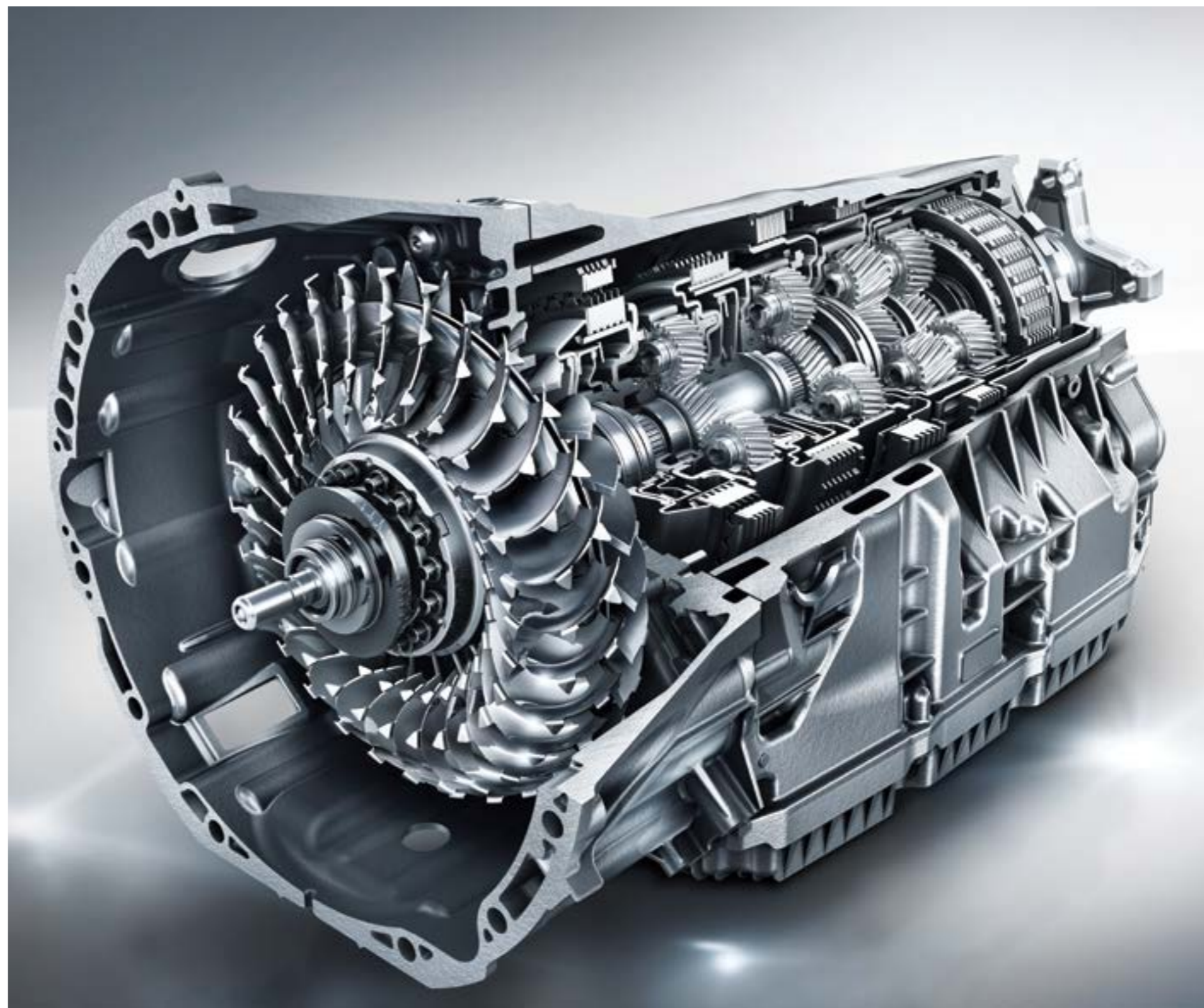



AIR BODY CONTROL. Air-bound comfort (Available with AMG Line).

The AIR BODY CONTROL air suspension features for the first time on the new E-Class. The multi-chamber air suspension system works in unison with continuously variable damper control to ensure a very high standard of ride comfort and driving dynamics. The damping system adjusts to the given driving and road conditions at each wheel. This is done rapidly and precisely using separate valves for the compression and rebound of the dampers. The benefits are a soft basic suspension and, as the speed increases, the secure feeling that comes from the high level of driving stability. The tauter spring rate effectively reduces pitching and rolling when cornering or braking, for example. Thanks to the pneumatic all-round self-levelling suspension, the vehicle maintains a constant level irrespective of the load. The suspension can be raised by up to 25 mm to increase ground clearance. At high speeds the suspension is automatically lowered, helping to reduce aerodynamic drag and further improve handling stability.



Mercedes-Benz E-Class

Design

LED high performance headlights

The LED high-performance headlights offer more safety at night and an unmistakable, striking look. Thanks to LED technology, they illuminate the road better than conventional headlights - with lower energy consumption. The adaptive rear lights in LED technology adjust their light intensity to the ambient conditions.



Panoramic sliding sunroof

Whether open or closed, with the panoramic sliding sunroof, you experience a wonderful feeling of freedom and enjoy a pleasantly bright ambience in the interior. When viewed from the outside, the large sliding sunroof likewise makes a unique visual impression, as it lends lightness and exclusivity to the exterior.



Illuminated door sill panels with “Mercedes-Benz” lettering

Even getting in and out becomes an experience in itself. As part of this, the high-quality stainless-steel sill panels are illuminated with striking “Mercedes-Benz” lettering. This shows that you value modern luxury.

Mirror package

The Mirror Package combines a number of useful functions for day-to-day driving: electrically folding outside mirrors protect your vehicle from annoying damage when parking, the lowerable outside mirror on the front passenger side makes parking easier and the self-dimming function protects your eyes.



Exterior – New E, New Attitude.

HIGHLIGHTS AT A GLANCE

- LED high performance headlights
- Power domes on the bonnet
- Powerclose door function
- Active brake assist
- Panoramic sliding sunroof
- Mirror package
- AMG body styling
- Sporty side skirts
- Air body control suspension (Exclusive to AMG Line)
- Diamond grille with AMG bumpers
- 45.7 cm (18-inch) AMG light-alloy wheels in 5-twin-spoke design
- Logo Projector





Interiors - Best in class comfort & convenience.

HIGHLIGHTS AT A GLANCE

- MBUX with “Hey Mercedes”
- Mercedes me connect
- New Generation steering wheel finished in beige and black
- Dual 31.2 cm (12.3-inch) widescreen cockpit
- THERMOTRONIC automatic climate control
- Ambient lighting
- EXCLUSIVE interior
- Rear reclining seats
- Rear electrically adjustable memory seats
- Electric sunblind
- Velour floor mats
- Wireless charging in the rear
- Burmester® surround sound system



DYNAMIC SELECT

The DYNAMIC SELECT driving programs change the driving behavior of your Mercedes at the push of a button. For example, you can use it to control the characteristics of the engine, transmission, chassis and steering to match the driving situation: whether dynamic in sport mode, completely relaxed in comfort mode or particularly economical in eco mode. You determine the style of your ride.

New Touchpad

Using the touchpad, you can operate the display of the infotainment system as you would a smartphone. Shift or enlarge the content quite simply with single gestures. Each input is confirmed with haptic feedback. The touchpad recognizes your handwriting should you wish to enter addresses or phone numbers.



Multifunction steering wheel

The multifunction steering wheel in nappa leather combines fine materials with innovative ease of use. You can use the touch control panels to control the most important vehicle functions without having to take your hands off the steering wheel.



Burmester® surround sound system

The unique sound systems from Burmester ensure first-class ambient sound in the new E-Class. It can even be optimized for each seat area on the front and rear seats. This gives you an even more intensive listening experience.



THERMOTRONIC automatic climate control

The THERMOTRONIC automatic climate control system with three climate zones and three climate styles provides an individual feel-good atmosphere on board. The driver and front passenger are able to set the temperature, air distribution and climate style to suit their personal needs. The third climate zone is in the rear - with separately adjustable temperature and airflow.

Ambient lighting

Showcase the interior according to your personal preferences or current mood. The 64 colors of the ambient lighting create exciting color schemes, which can alternate dynamically or illuminate several areas in different colors. The ambient lighting promotes a sense of well-being while driving. In all ten color schemes the colors can alternate to spectacular effect - if so desired. Just as variably adjustable is the brightness of the LEDs, with settings for ten levels and four zones (widescreen cockpit, front seats, rear and entire dimming zone).



E-Class Interiors

Show that elegant individuality is close to your heart: with the EXCLUSIVE interior you get the interior design of your Mercedes exactly the way you like it. Opt for one of the two colour concepts and showcase your elegant interior perfectly with the ambient lighting.

Seats for driver and front passenger with vertical quilting on seat surfaces:

- Upholstery in ARTICO man-made leather with Seat Comfort Package: Electric and manual adjustment options for an ergonomic seat position
- 3-spoke multifunction steering wheel in nappa leather with touch control panels and alvanised steering wheel
- Ambient lighting with 64 colours and 3 light zones
- Silver open pore ash wood trim
- Dashboard and Door centre panels: ARTICO man-made leather with topstitching in Black or Beige and Beige with Tropez Blue
- Beltlines and armrest on the centre console: in Black or Beige, finished with topstitching



Reclining Rear Seats with Memory function

The electric rear seats ensure tailored ride comfort. The 3-seat long rear seats include 2 lateral luxury seats. The backrest can be tilted up to 37 degrees, allowing passengers to take a more relaxed angle. The seats come with luxury headrest which elevates the comfort of the passenger. The memory function can store up to 3 separate positions for each seat, and can be recalled quickly. The memory program includes all seat backrest and headrest adjustment functions. The ergonomically designed switch on the door control panel can be used for intuitive control.



Comfort Headrest

More comforts include a luxurious headrest with manual adjustable side braces and a comfortable additional pad. Integral luxury armrest comes with a tray with antiskid material to dock smartphones or small tablets, elegant and yet practical.



4-way lumbar support

For an ergonomic seating position and relaxed back muscles. The 4-way lumbar support is a small detail which has a big impact. It adapts the seat contour to your lumbar spine and gives it support. Four settings are possible: higher, lower, weaker or stronger.



Electric sunblind

The electrically extending and retracting roller sunblind for the rear window protects against harsh direct sunlight in summer and when the sun is low in the sky. As a result, as the driver you can ensure that you are not dazzled by sunlight coming from the rear. In addition, the interior heats up less. Visibility to the rear is maintained.

Velour floor mats

The velour floor mats further enhance your interior. They are provided in the respective appointments colour with matching edging, thus ensuring that they blend perfectly into the interior design. In addition, the mats protect the footwell against dirt – they can be removed very rapidly to be vacuumed or cleaned.





Mercedes-Benz E-Class

Technology

MBUX features in the all-new E-Class



Display styles

You can customise the design and the entire look and feel of the Widescreen Cockpit. There is a choice of four display styles: "Classic", "Sport", "Progressive" and "Subtle". The chosen style tangibly characterises the interior atmosphere, especially in conjunction with the available ambient lighting.

Natural voice control

"Hey Mercedes." These two initial words start the natural, intuitive LINGUATRONIC voice control system which comes as standard. It reacts to almost every word. The system can even process indirect speech – the air conditioning will respond, e.g. to "I feel cold" and increase the temperature setting. At the same time the voice control also has learning capability. It attunes itself to your voice and thus understands you better.

Touch control concept

MBUX offers users maximum freedom for controlling all functions in the way most comfortable and convenient to them. Whether using voice control or intuitive touch functions. The new E-Class comes with the option of a multimedia touch display. There is also a touchpad integrated in the centre console, which responds to single and multi-finger gestures as well as handwriting. Furthermore, the displays can be controlled using Touch Control buttons on the steering wheel.

Smartphone Integration

The smartphone Integration merges the mobile phone with the media system via Apple® CarPlay® and Android Auto®. This gives you convenient access to the most important applications on your smartphone. You can also use third-party apps such as Spotify quickly and easily.



Widescreen cockpit

Inspirational design meets a fully digital display with flexible presentation options: the widescreen cockpit enables information to be truly experienced. The desired content can be positioned individually and the host of functions controlled intuitively thanks to touch technology.



Mercedes me connect allows drivers to stay in touch with their vehicles from anywhere in the world and to obtain assistance at the touch of a button.

Mercedes me

Vehicle Monitoring

Vehicle Tracker: Track your vehicle from anywhere, as your vehicle's GPS coordinates are seen on your phone App.

Parked Vehicle Locator: It can locate your parked vehicle within a radius of 1.5 kilometres and show you on a map how to make your way back to the vehicle.

Navigation Connectivity package

The combination of the standard-fit communication module (LTE) and the hard-disc navigation makes sure that you always reach your destination as quickly as possible by the best route.

Vehicle Set-Up

Remote Retrieval of Vehicle Status: Information on Mercedes me App or the Mercedes me Portal.

Remote Door Locking and Unlocking: You can conveniently remotely lock or unlock your vehicle from the Mercedes me App.

Speed Alert: Receive an alert if your vehicle exceeds a certain speed.

Send2Car function: Send your address to your vehicle via an app.

Remote Engine Start

Mercedes-Benz emergency call system

The Mercedes-Benz emergency call system can save you vital minutes in an emergency. If an accident is detected, a communications module with its own SIM card automatically triggers an emergency call which could shorten the time until rescue services arrive.

Please note that certain services are offered free of cost for a period of three (03) years and may be chargeable at the expiry of three (03) years from the date of activation of such services. If you wish to continue using those services, you may renew the same through Mercedes Me Store (as and when it is available). Please get in touch with your preferred Franchise Partner for more details.

Mercedes me

Vehicle Finder (enables horn and light flashing)

Find your vehicle in large parking lots with ease. Simply blow the horn or flash the headlamps through the app to locate your vehicle

Mercedes me Service app: Your digital assistant

Keep a tab on your Star's maintenance with ease. Get timely maintenance and service reminders. Book a service appointment and search for nearest showrooms with a single touch.

What's more, access expert tips to keep your Star in its best shape with car care videos.

Geo-fencing

Set a perimeter for the car movement and receive notifications in case of vehicle movement beyond the parameter. Hence the feature enables easy monitoring when vehicle is being driven by others.

Windows/sunroof open close from App

Open/Close the windows and sunroof of your Mercedes-Benz remotely through the app. This enables better ventilation before you get into the car.



Mercedes me

Additional Mercedes me connect features

Alexa Home Integration with Mercedes me

connect: Conversations with Alexa are now more fun when the systems connect with your Mercedes Benz via cloud and give you real time updates. This feature can be used from an Alexa Echo device setup at home, office or also from phone's Alexa App. The command starts with "Alexa, Ask Mercedes to...." or directly initiate a command by saying "Alexa, tell Mercedes to <command>".

Google Home integration with Mercedes me connect: Google Home integration is also offered for Google home users. In a similar way, once the Mercedes me connect is linked to Google Home, you can start issuing commands.

Parking location POIs (Points of Interest): The introduction of new Parking solution, shows Parking lots available across different parts of the cities. The Parking POIs (Points of interest) can be seen easily on the navigation system or alternatively also on the Mercedes me App maps section.

Please note that certain services are offered free of cost for a period of three (03) years and may be chargeable at the expiry of three (03) years from the date of activation of such services. If you wish to continue using those services, you may renew the same through Mercedes Me Store (as and when it is available). Please get in touch with your preferred Franchise Partner for more details.

*Please read the disclaimer





Mercedes-Benz E-Class

Safety

Safety and Assistance

Active Brake Assist - helps to prevent rear-end collisions and accidents with crossing pedestrians

Insufficient distance from the vehicle in front and inattentiveness are the main causes of serious accidents. Active Brake Assist can help prevent accidents with vehicles in front and with crossing pedestrians and/or mitigate the consequences of accidents. To this end, the radar-based driver assistance system activates a visual distance warning depending on the situation and, if necessary, an additional audible collision warning. When the driver steps on the brakes, he or she is helped, if necessary, by situation-dependent braking assistance in the form of additional braking force. This is only an 'Assist function' and does not necessarily brake the vehicle by itself.

*Always pay careful attention to the traffic/pedestrian crossing situation; do not rely on Active Brake Assist alone.

Active Brake Assist may not function if: In snow, rain, fog, heavy spray, if there is glare, in direct sunlight or in greatly varying light conditions. If the sensors are dirty, fogged up, damaged or covered. If the sensors malfunction due to other radar source interference. If a loss of tire pressure or a defective tire has been detected.

The system may not react correctly if: In complex traffic stations where objects cannot always be clearly identified. Pedestrians or vehicles move quickly into the sensor detection range. Pedestrians who are hidden or not recognized due to other objects. If the typical outline of a pedestrian cannot be distinguished from the background. On bends with a tight radius.

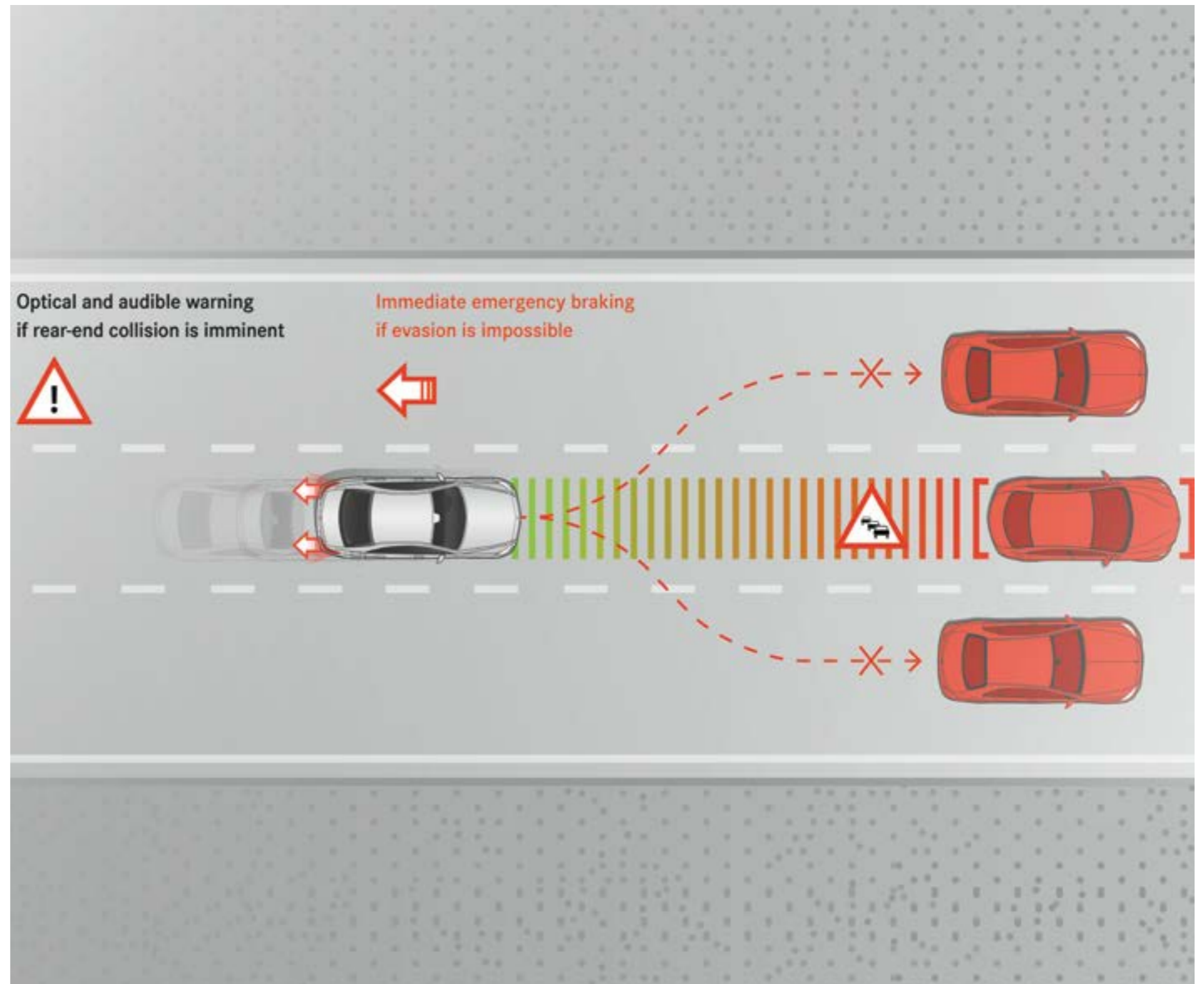

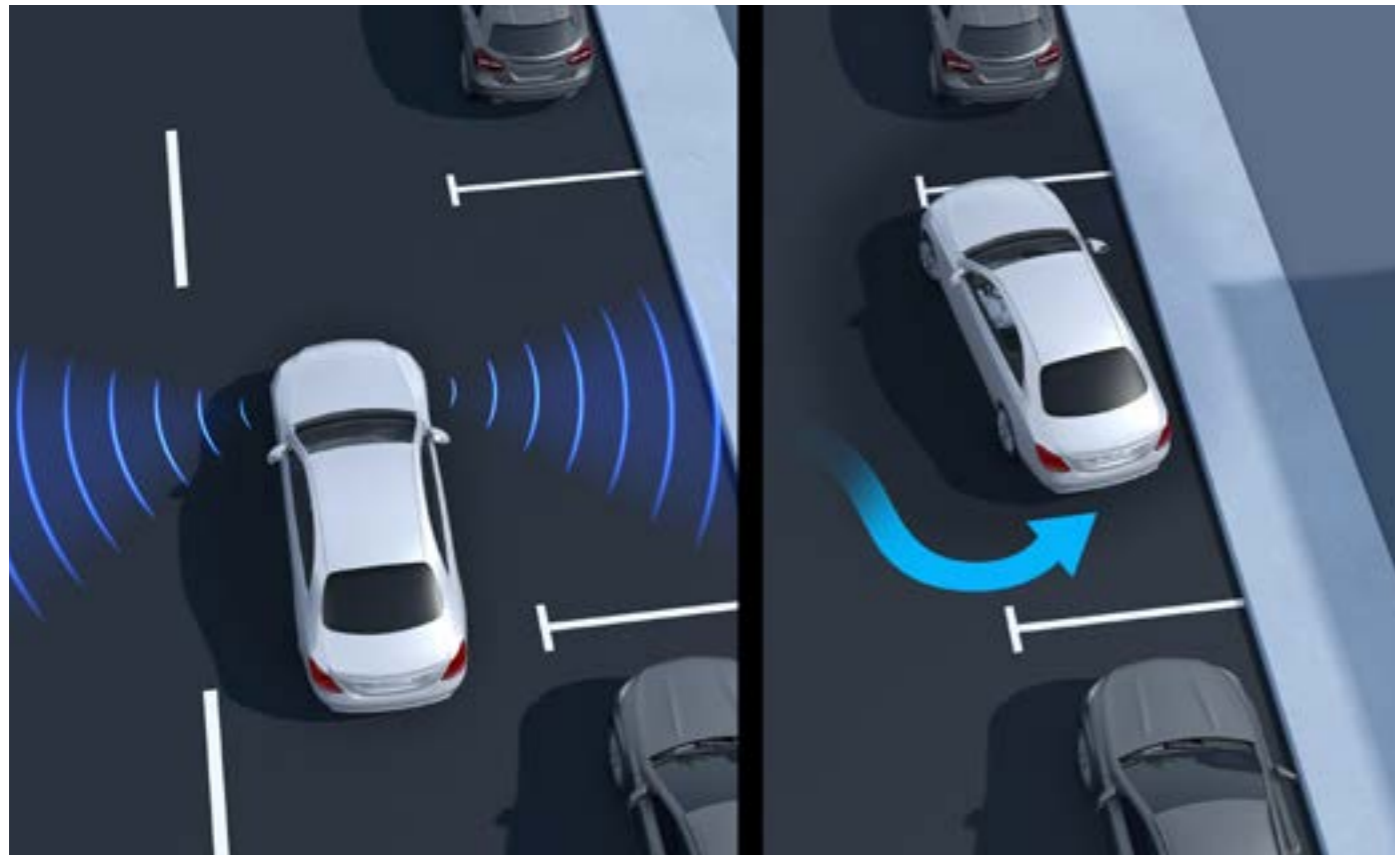

Active parking assistant with PARKTRONIC

Transform the stress of narrow parking spaces into confident serenity. Active Parking Assist with PARKTRONIC can not only find parking spaces - it also supports you when parking and leaving. It assists you with steering and, in vehicles with automatic transmissions, also with accelerating, braking and changing gears.

360 degree camera

The 360° camera provides a realistic image via the head unit, thus offering assistance when parking and manoeuvring. The camera is switched on automatically when reverse gear is selected. Alternatively, it can be activated by the driver whenever required. The vehicle and its immediate surroundings can be shown as a bird's-eye view on the head unit's Media Display, obstacles near the vehicle but below the window line are also visible to the driver.

Expression and Exclusive models are equipped with wide angle rear view camera.

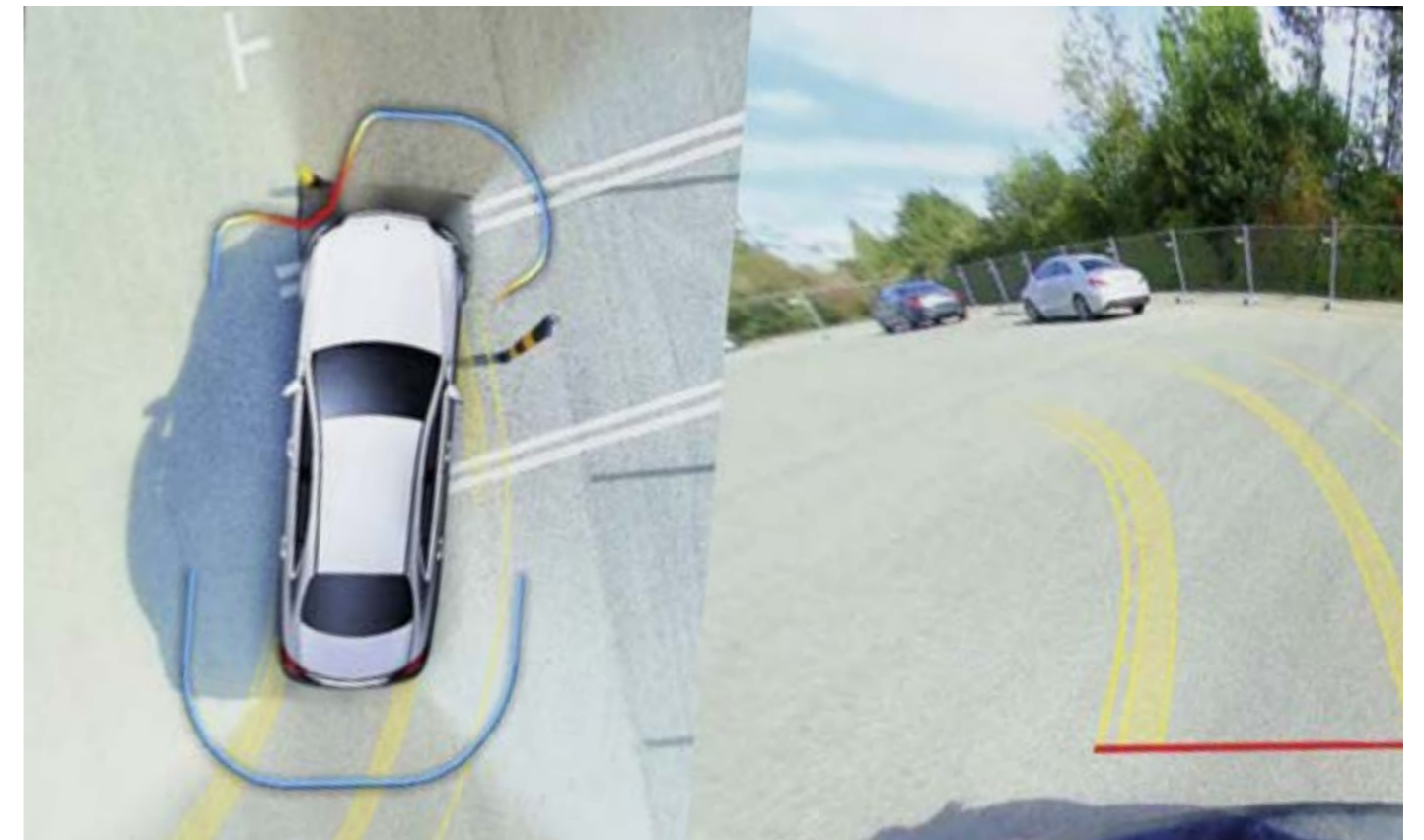

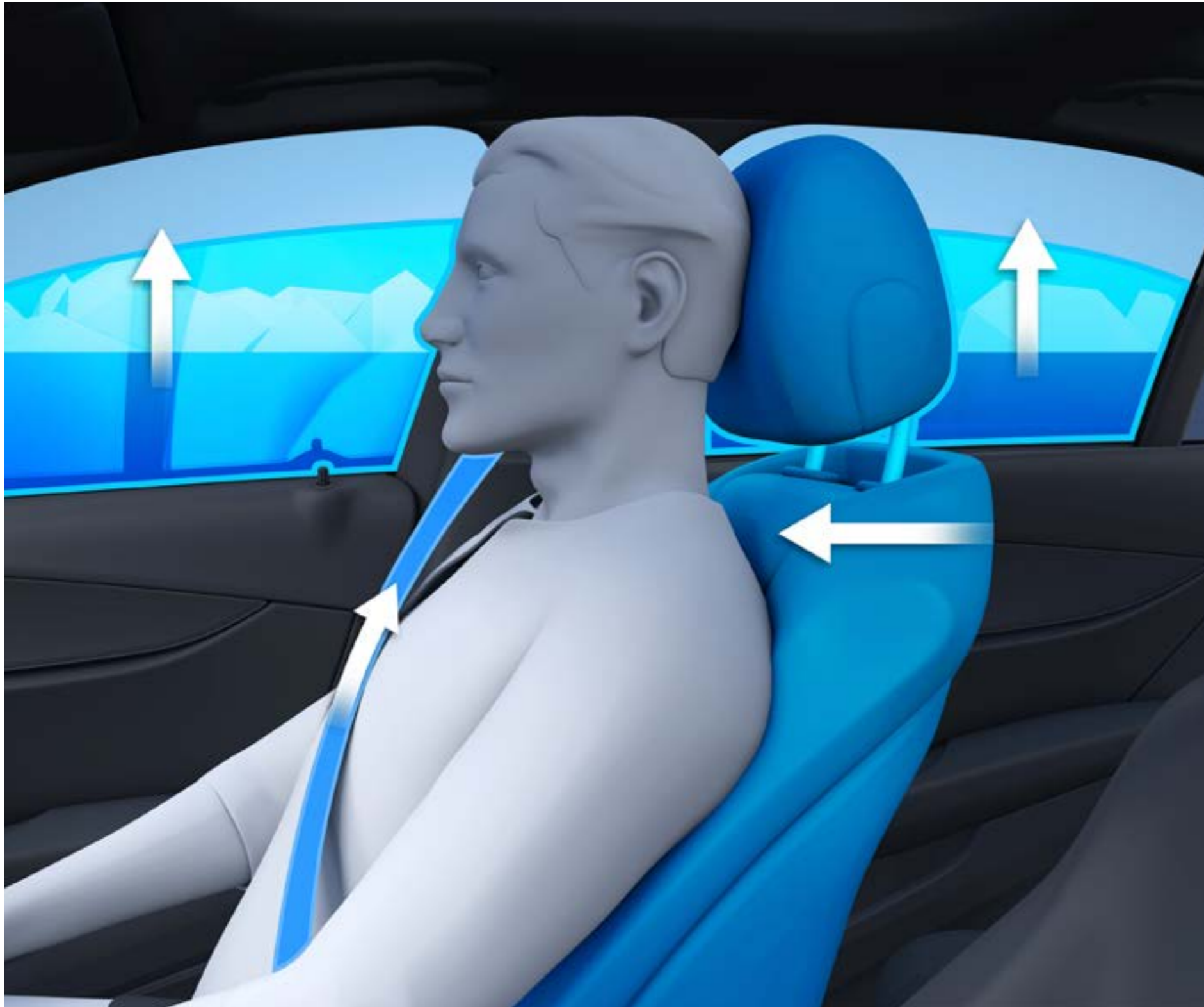

PRE-SAFE®

The PRE-SAFE® system makes use of the time prior to an impending accident on your behalf. A host of measures are able to reduce the stress and strain to which you are exposed. The innovative PRE-SAFE® sound generates a noise from the speakers which is able to trigger a natural protective reflex: this protects the inner ear by damping the accident noise.



Kneebag

The kneebag protects your legs from contact with the steering column or the instrument panel in the event of a severe frontal crash. This can prevent or mitigate injuries. The air cushion unfolds in milliseconds and stabilizes the whole body. The entire restraint system, including the seat belt, works together as well as possible.



Power closing

This is how quality sounds and feels: the power closing function closes your doors smoothly and almost silently. For this you only need to close the door as far as it starts to engage - and your vehicle will take over the rest for you.

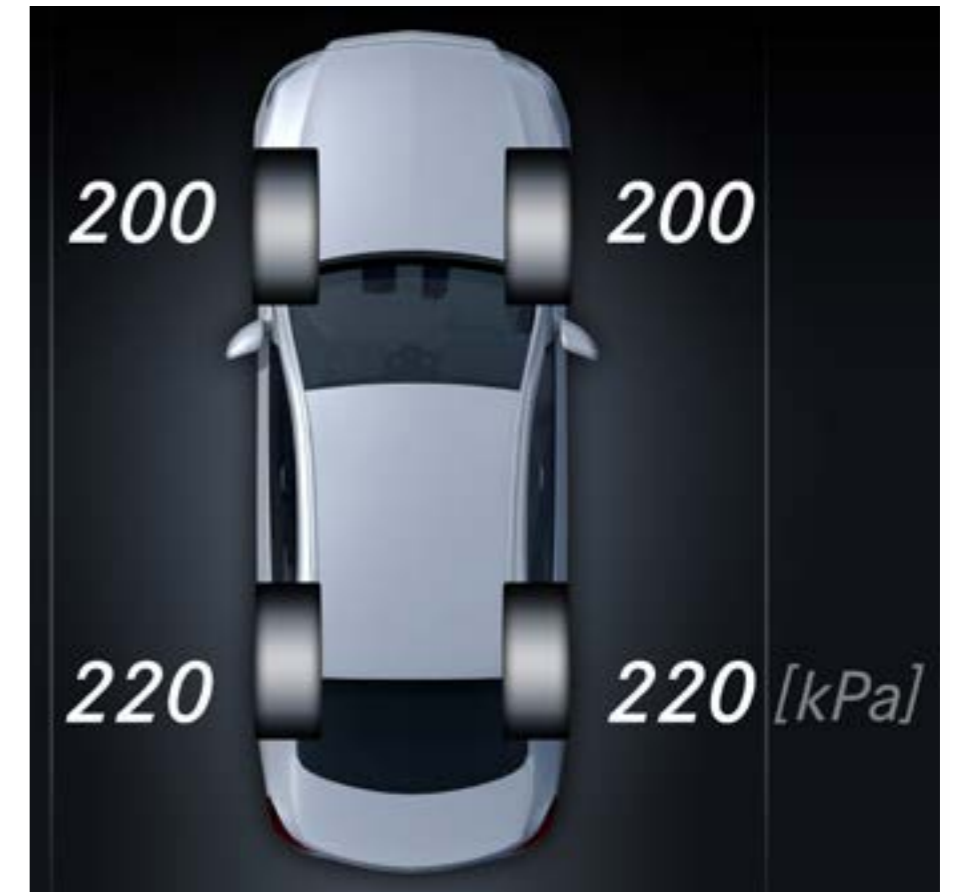

Tire pressure monitoring system

The system monitors the tire pressure for you and provides you with a warning in the event of a drop in pressure. This way you can react more quickly to this hazardous situation. Too low a tire pressure can also result in longer braking distances. When the control system notifies you, you should top up the air quickly. Correct tire pressure additionally increases mileage.

Paintwork

Polar White Non-Metallic



Obsidian Black Metallic



High-Tech Silver Metallic



Graphite Grey



Upholstery



Beige with brown



Beige with Tropez blue



Black

Trim



Grey open-pore ash wood trim

Alloy



45.7 cm (18-inch) AMG light-alloy wheels in 5-twin-spoke design

Technical Data

	E 200	E 220d	E 350d
No. of cylinders/arrangement	4/in-line	4/in-line	6/in-line
Total displacement in cc	1991	1950	2925
Rated output in kW (hp) at rpm	145 (197)/5500 - 6100	143 (194)/3800	210 (286)/3400 - 4600
Rated torque in Nm at rpm	320/1650 - 4000	400/1600 - 2800	600/1200 - 3200
Transmission	9G-TRONIC	9G-TRONIC	9G-TRONIC
Acceleration from 0 to 100 km/h in sec	7.6	7.6	6.1
Top speed, approx. in km/h	240	240	250

Dimensions

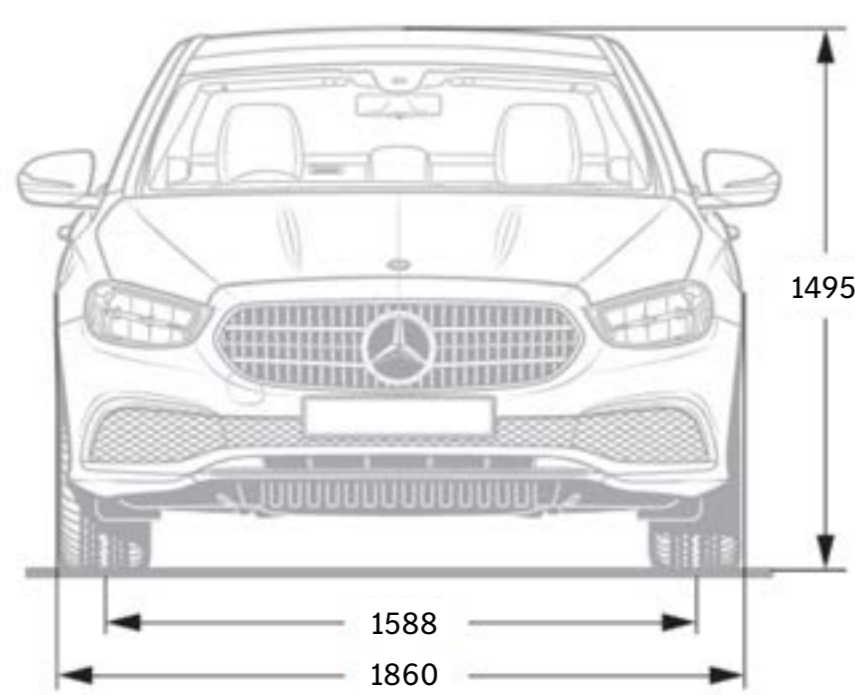

Front

Back

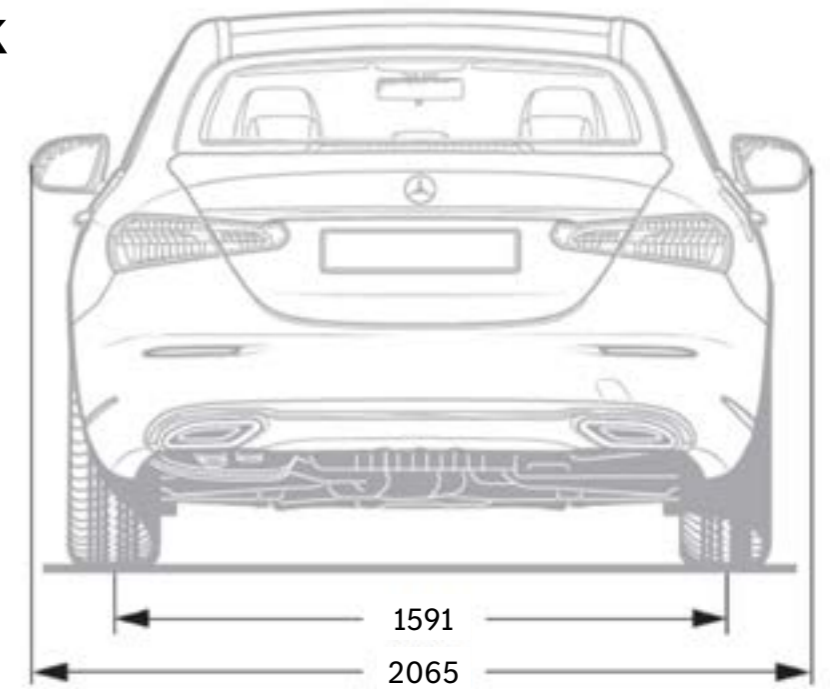

Side

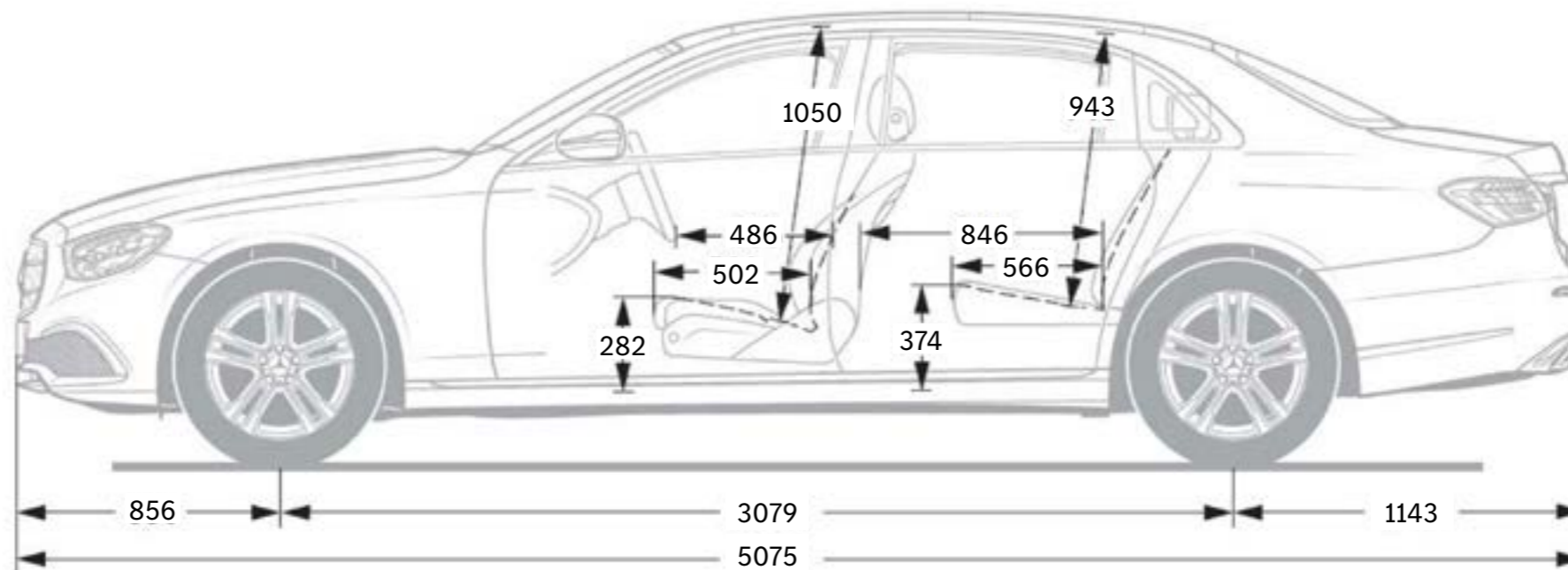



My Mercedes. My Service

Advance Assurance Program

Extending your warranty coverage

With Advance Assurance Program, experience complete peace of mind. While this Extended Warranty Program kicks in the moment your standard 3 years warranty comes to an end, it can be extended further up to 6 years at a nominal price. Also, it comes with a bouquet of privileges for a worry-free time with your Star.

STAR EASE

Delivering the best-in-class value

Servicing your Star does not get any better than this. With the STAR Ease Maintenance Packages, pay a defined cost of maintenance based on the model, contract period and mileage and say goodbye to spending on service every time. Plus, enjoy exclusive features like priority handling, shorter waiting time and quicker processes.

My Mercedes. My Service

MOBILO

Providing you 24x7 mobility support

Your vehicle comes with Mobilo which provides round-the-clock on-road assistance service. Mobilo comes as a standard for 3 years and can be extended further up to 8 years at a nominal cost. This service offers privileges like vehicle towing facility, replacement vehicle, hotel accommodation, just to name a few.

Digital Service Drive

Ensuring convenience and transparency of service.

Servicing your Star is the last thing you will ever have to worry about. We provide transparent, convenient and hassle-free service. Our customer-friendly service features work around your busy schedule so that you have one less thing to focus upon.





My Mercedes. My Service

Mercedes-Benz Genuine Parts

Now with 2 years* of warranty

Mercedes-Benz Genuine Parts are crafted to the state-of-the-art standards of Mercedes-Benz, protecting your vehicle's performance while maintaining the style, comfort and safety, for the years to come. Also, they come with a warranty of up to 2 years, ensuring you a peaceful ownership experience with your Star.

Premier Express*

Because we value your time as much as you do.

Life gets busy and so we have designed Premier Express, our vehicle care service to help you get in and out quickly. While the visit will be brief, the service offered by our technicians will be comprehensive and complete. All to ensure your Mercedes-Benz is running for miles to come.

My Mercedes. My Service

Mercedes-Benz Approved Tyres and Rims

Ensuring every ride is a safe and joyful one

Maximise the safety and comfort of your Star with Mercedes-Benz approved tyres and rims. While the Mercedes-Benz approved tyres are designed to optimally match your car's performance, the Mercedes-Benz approved rims are designed to lend an exceptional style to the exterior of your Star and are also engineered for optimal performance.

Mercedes-Benz Genuine Chemical Products

Because your Star deserves nothing but the original

Mercedes-Benz Genuine Chemical Products are specially tested for compatibility with the materials in our cars and meet the high quality standards. Also, our products have been approved under Mercedes-Benz Group AG's strict, self-imposed environmental norms. Now with Mercedes-Benz Genuine Chemical Products, experience a whole new world of superior products that support throughout the car's life cycle.





Mercedes-Benz India Private Limited: E-3, MIDC Chakan - Phase III, Chakan Industrial Area, Kuruli & Nighoje, Tal: Khed, Pune - 410 501 (India) Toll free No.: 0008000501888. e-mail: cs.ind@cac.mercedes-benz.com, website: www.mercedes-benz.co.in Please note: This brochure is intended for general information, description and illustration of the Product including optional functions and equipment and may not be specific to a Product since specification of a product may change from time to time. Optional features, functions and equipment etc. may not be present in the Standard or Variant Product or Special Edition Product. Further, Standard specifications of a product may also vary from time to time. Colours may differ from those shown in pictures in the brochure. Mercedes-Benz India reserves the right to make changes without prior notice, in design, colours, materials, components, equipment, specifications, features, functions, make and models etc. The information given in this brochure shall be regarded as accurate at the time of launch and may vary thereafter due to any developments or any other reason. Interested customers should reach out to the Authorised Franchise Partner for further information on the exact specifications, features of the product.

Images shown are for representation purposes only. Some of the vehicles in the Brochure are left hand drive wheel. However, Mercedes-Benz India only manufactures and sells vehicles as per the applicable motor vehicle regulations in India. All vehicles sold by Mercedes-Benz Authorized Franchise Partners shall be with right hand drive wheels only. All title, ownership rights and intellectual property rights in and relating to this brochure/magazine or publication material or any copies thereof including but not limited to copyright, logos, names, trademarks, service marks, design, text, images, links, concepts and themes are owned by Mercedes-Benz Group AG and/or its subsidiaries collectively or used under authorised license by the Mercedes-Benz Group AG. Any reproduction, transmission, publication, performance, broadcast, alteration, license, creation of derivative works or other use in whole or in part in any manner without the prior written consent of Mercedes-Benz India Pvt. Ltd is strictly prohibited. Please note that certain services are offered free of cost for a period of three (03) years and may be chargeable at the expiry of three (03) years from the date of activation of such services. If you wish to continue using those services, you may renew the same through Mercedes Me Store (as and when it is available). Please get in touch with your preferred Franchise Partner for more details. Mercedes-Benz cars: The E-Class LWB meets Bharat Stage VI equivalent emission norms.
CIN - U34102PN1994PTC083160